

User Manual

BLUETTI AC500

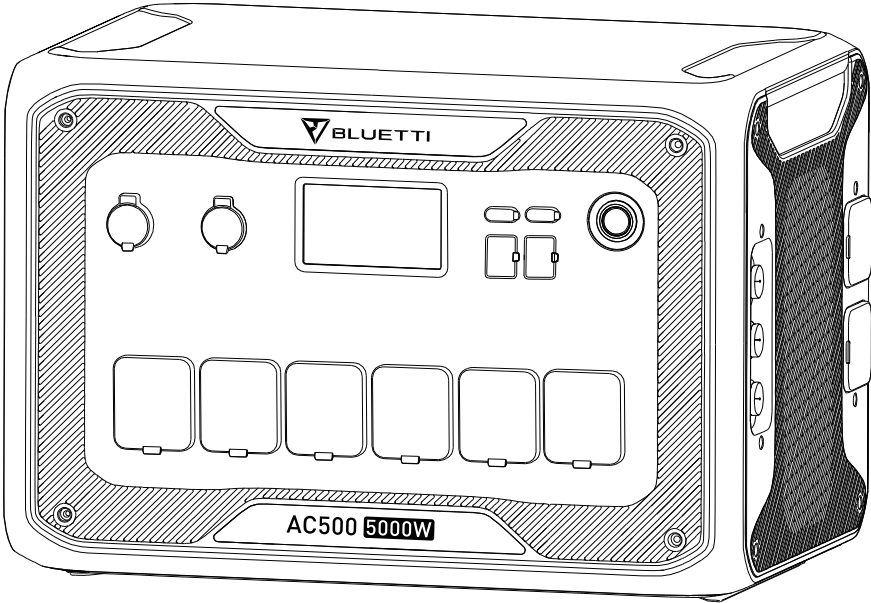



Thank You!

Thank you for making BLUETTI a part of your family.

From the very beginning, BLUETTI has tried to stay true to a sustainable future through green energy storage solutions for both indoor and outdoor use while delivering an exceptional eco-friendly experience for our homes and our world. That's why BLUETTI makes its presence in 70+ countries and is trusted by millions of customers across the globe.

Contents

Before You Begin	1
Safety Instructions	2
General Safety	2
Maintenance	3
Handling & Storage	3
What's In The Box	4
Standard Packaging	4
Product Overview	6
Diagram	6
Specifications	7
Operation	9
Powering On/Off	9
LCD Screen	9
Charging	10
Discharging	14
Capacity Expansion	15
UPS	15
BLUETTI App	17
Power Lifting Mode	17
Appendix	18
FAQs (Frequently Asked Questions)	18
Technical Support	18

Before You Begin

The information contained herein is subject to change without notice.

For the latest version of this user manual, please visit

<https://www.bluettipower.eu/pages/manuals>.

- The user manual contains instructions and notes on the operation and use of this unit.
- BLUETTI recommends that you use genuine accessories from BLUETTI.
- BLUETTI shall not be responsible for any damage or expense that might result from the use of parts other than genuine parts from the BLUETTI.
- For your safety and benefit, please read carefully before using and keep it handy for future reference.

Safety Instructions

General Safety

BLUETTI products are developed to be safe and reliable. Please read this guide for important safety information about your device. The guide is intended to help you be more comfortable and productive while using this device. Failure to follow these guidelines for proper set up, use, and care for your device may cause damage to this unit and injury to yourself or others.

【SAVE THESE INSTRUCTIONS!】

- Always operate or store the unit within the specified temperature range.
- DO NOT expose the unit to fire, liquids, sweat, dirt or other contaminants, as that may cause explosion or other safety risks.
- DO NOT place the unit on an unstable or tilted surface.
- Make sure the place where you are using the unit is well ventilated and spacious.
- Keep away from children and pets.
- DO NOT ignore those warning signs on components or products made by manufacturers.
- DO NOT dismantle, cut, crush, puncture, or otherwise damage the unit in any way.
- DO NOT insert foreign objects into the fan, vents, ports, or other openings.
- NEVER use a damaged battery or component. Improper use or misuse of damaged batteries may cause damage to your device or injury to yourself as a result of battery fluid leakage, fire, overheating, or explosion.
- Use approved battery and accessories ONLY. Improper use, or use of unapproved or incompatible batteries or components may result in a risk of fire, explosion, or other hazards, and may invalidate any approval or warranty.
- Turn off the unit IMMEDIATELY in case of malfunction.
- Use dry powder fire extinguisher in case of fire.
- DO NOT attempt to modify, replace the internal battery or any other component of the unit by anyone other than qualified personnel. If necessary, take it to an authorized service center as incorrect reassembly may result in a risk of fire or electric shock.

Maintenance

- When not using the unit for extended periods of time, power off the unit and disconnect the AC charging cable from the outlet.
- Charge the unit to 50-70% SOC every 6 months for long-term storage.
- Clean the unit with a dry cloth gently and carefully.

Handling and Storage

- Use mechanical assistance as needed(e.g. trolleys and adjustable height workbenches).
- DO NOT stack anything on top of the unit either in storage or in use.
- Recommended storage temperature: -13-104°F/-25-40°C.

What's In The Box

Standard Packaging

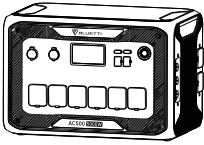

Portable Power Station

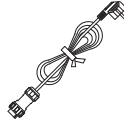

AC Charging Cable



DC Input Cable



Car Charging Cable



User Manual

* Below accessories are not included in standard packaging and can be purchased separately at <https://www.bluettipower.eu/>.

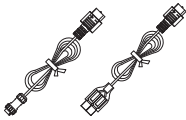

30A RV Cable



Lead-acid Battery
Charging Cable



D300S PV Voltage Step
Down Module



Cigarette Lighter-F to
DC5521 Cable (24V)



32A Aviation Plug

* **AC Charging Cable:** 59in/150cm.

DC Input Cable: 59in/150cm. Aviation-MC4.

Car Charging Cable: 19.7in/50cm.Cigarette Lighter Port-MC4.

30A RV Cable: Aviation-XT60, 31.5in/80cm;
XT60-SPC45, 19.7in/50cm.

Lead-acid Battery Charging Cable: 19.7in/50cm. Clamp-MC4.

D300S PV Voltage Step Down Module: 65in/165cm(output cable).

Cigarette Lighter-F to DC5521 Cable(24V): 28.3in/72cm.

32A Aviation Plug: Used to obtain 5000W AC output.Please refer to AC500
32A Aviation Plug Guide for details.

Note: All measurements are for reference only.
Package details are subject to change without prior notice.

Product Overview

Diagram

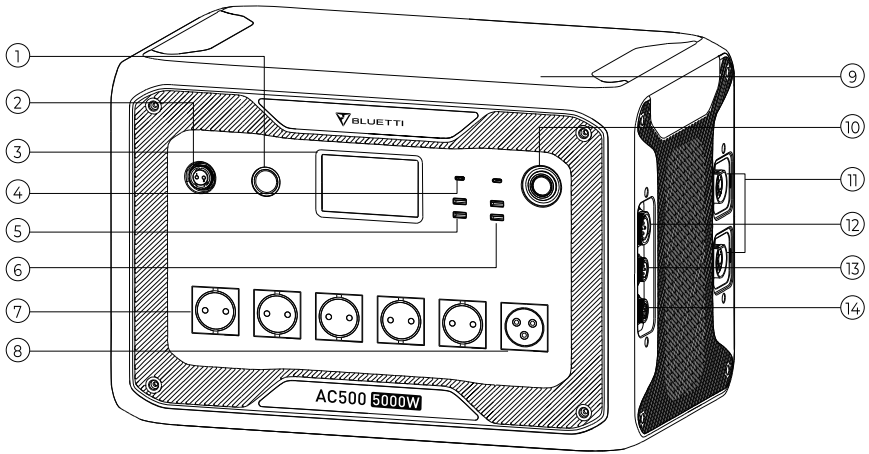

- | | |
|-------------------------------|----------------------------|
| 1. 24V Cigarette Lighter Port | 8. 32A AC Output |
| 2. 12V/30A RV Port | 9. Wireless Charging Pad |
| 3. LCD Screen | 10. Power Button |
| 4. USB-C PD3.0 | 11. Battery Expansion Port |
| 5. 18W USB-A Port | 12. AC Input |
| 6. USB-A Port | 13. DC1/DC2 Input |
| 7. 16A AC Output | 14. Communication Port |

Specifications

AC500

General

Battery Capacity (With 1-6 B300S)	3072-18432Wh/60-360Ah	
Dimensions (L*W*H)	20.5*12.8*14.1IN/520*325*358MM	
Weight	66.2LB/30KG	
Discharging Temperature	-4-104°F/-20-40°C	
Charging Temperature	-4-104°F/-20-40°C	
Storage Temperature	-13-104°F/-25-40°C	
Over Temperature Protection (With B300S)	Discharging	65°C (Recovery at 55°C)
	Charging	55°C (Recovery at 45°C)
Working Humidity	10-90%	

AC Output

Power	5000W
Surge	10000W
Voltage	220-240VAC
Current	21.7A
Frequency	50/60Hz
Overload	5000-6000W, 2min 6000-7500W, 5s 7500-10000W, 500ms

DC Output

Cigarette Lighter Port *1	24VDC, 10A
12V/30A RV Port *1	12V, 30A Overload 418W, 2s
USB-A *2	5VDC, 3A
USB-A QC3.0 *2	18W Max. (3.6-12VDC, 3A)
USB-C PD3.0 *2	100W Max. (5/9/12/15/20VDC, 3A; 20VDC, 5A)
Wireless Charging *2	15W Max.

AC Input

Power	5000W Max.
Voltage	187-264VAC
Current	50A Max.
Frequency	47-63Hz

DC Input

Power	3000W Max.
Voltage	12-150VDC
Current	15A Max.

Note: If there's only one B300S, the combo gets a maximum of 4500W output.
When connecting B300S with T500 adapter or AC500 to the grid, B300S is able to self-heat and get charged even at -4°F/-20°C.

Operation

Powering On/Off

Startup and shutdown: Press and hold the power button on AC500 or B300S to turn the combo on or off.

AC/DC Output: Tap the 'AC ON/OFF' or 'DC ON/OFF' to enable or disable.

Operation	Green Light (On the Buttons)	LED Indicator (On B300S)
Powering On	ON	ON
Shutdown	OFF	OFF

Note: Turn on the DC power to enable wireless charging.
When connected to the grid or PV, the combo turns on automatically.
The combo turns off automatically upon 4 hours:
a: No input and output b: AC and DC output off

LCD Screen

Homepage

This section displays the charge/discharge status and navigates to detailed product information.

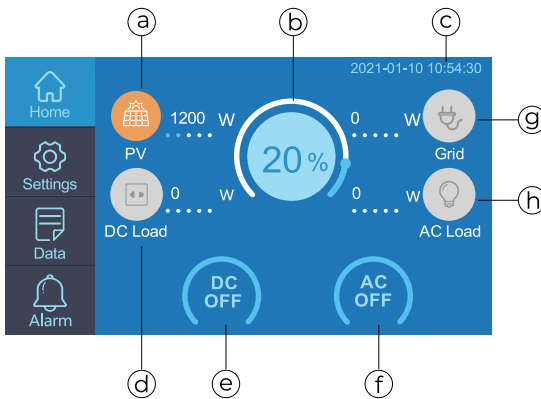

- a: PV Input
- b: Battery Capacity
- c: Date/Time
- d: DC Load
- e: DC ON/OFF
- f: AC ON/OFF
- g: Grid Input
- h: AC Load

Settings

This section provides general setting configurations, including language, AC/DC output and input, ECO mode¹, machine type, system date/time, etc.

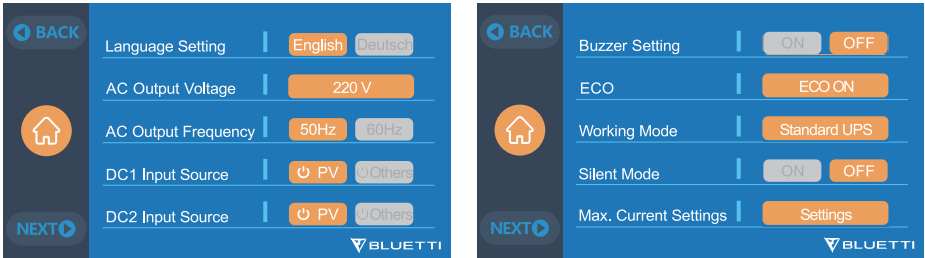

Note: Check all the settings before first use.

AC frequency and voltage can only be adjusted after AC output is turned off.
Voltage and frequency reference: EU/UK: 230V/50Hz AU: 240V/50Hz

Data

This section provides all basic information including product, inverter and charger, battery, and alarm history.

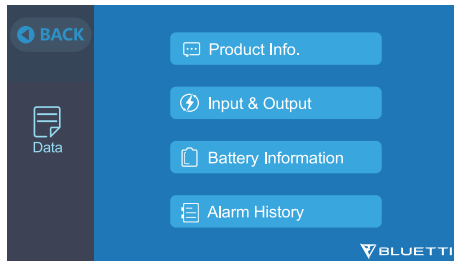

Note: 'Input & Output' indicates the input and output status of this unit;

'Battery Information' indicates the connection status of battery pack(s);

'Alarm History' records all alarms generated which can be manually deleted.

- ¹ When on this mode, the AC output will automatically turn off after 4-hour low($\leq 30W$) or no load to save power.

Charging

AC Charging

(1) Consider the specifications of utility, AC outlet and charging cable before setting the Max. Grid Input Current.

Note: The Max. Grid Input Current is set at 10A by default and only works when AC500 connects to the grid.

Email to BLUETTI Customer Service for password.

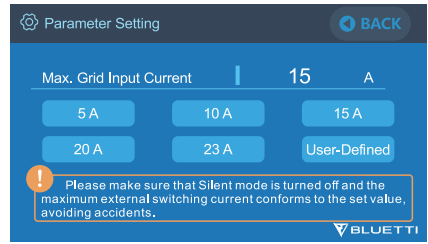
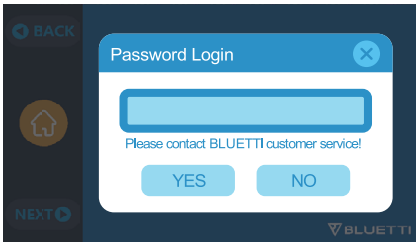

(2) Plug the AC500 into the wall outlet via the AC charging cable.

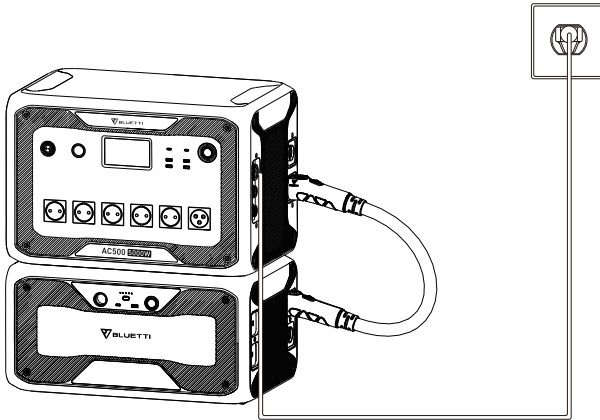

Generator Charging

Connect AC500 to the generator via the charging cable*.

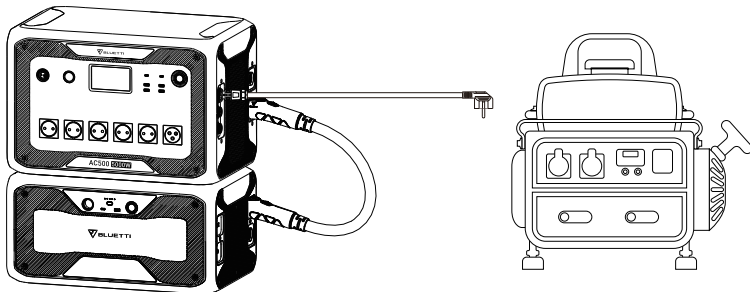

* Sold separately.

Note: BLUETTI recommends an inverter generator that delivers at least 5000W pure sine wave AC power.

Voltage and frequency limit: EU/UK: 195.5-253VAC/47-53Hz AU: 204-264VAC/47-53Hz

PV Charging

AC500 supports dual PV input with the DC input cable. Connect the solar panels (in series or parallel) to AC500 and CHECK the PV connection on LCD screen.

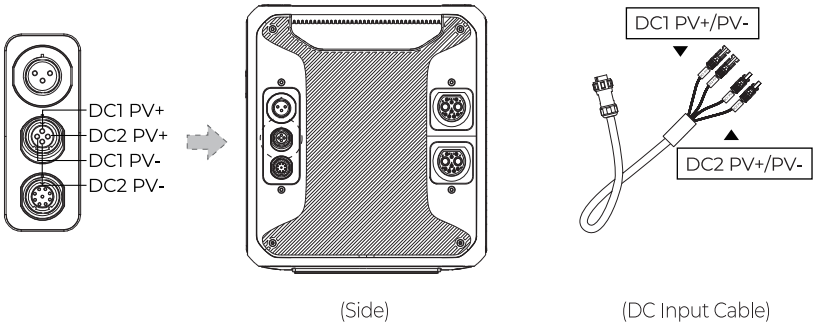

Note: Please make sure your solar panels at each input comply with:
 OCV: 12-150V V_{mp} : 12-150V Power: 1500W Max.

E.g. Connect three BLUETTI PV350 solar panels in series to DC1 or DC2.
 BLUETTI PV350: V_{oc} =46.5V V_{mp} =37.5V Current=9.2A Max.
 Total: V_{oc} =46.5×3=139.5V V_{mp} =37.5×3=112.5V Current=9.2A Max.

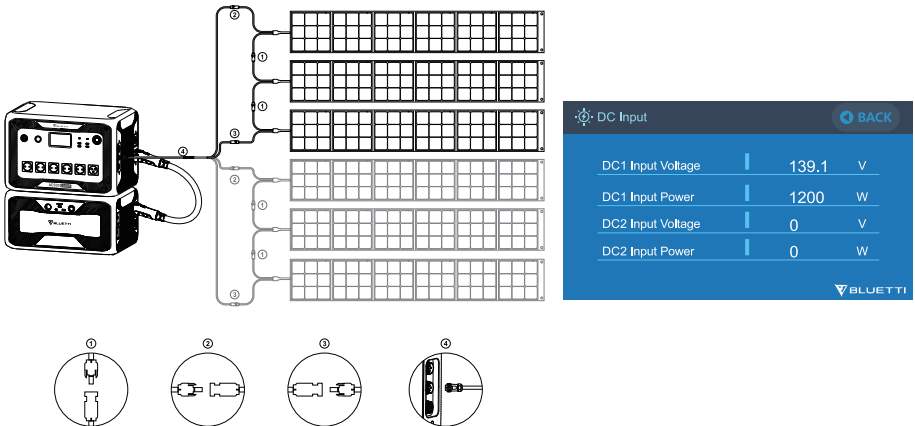

- ① OCV: Open circuit voltage, also for V_{oc} . The maximum voltage that the solar panel can produce with no load on it.
- ② V_{mp} : Voltage at maximum power. The voltage available when the panel is operating at its peak performance output.

The roof panel can also charge the AC500. If the panel's OCV falls in 150-550V, please use the D300S to lower the voltage. Find details in D300S PV Voltage Step Down Module User Manual.

Car Charging

Connect the AC500 to the vehicle plug-in cigarette lighter port via the DC input cable and car charging cable.

Note: Set the 'Others' as DC1/DC2 input source to enable car charging.
The Max. input current is 8.2A.

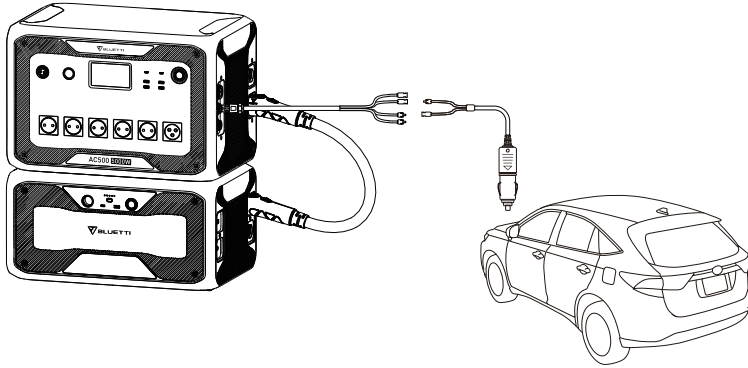

Lead-acid Battery Charging

Connect the AC500 with the lead-acid battery via the DC input cable and lead-acid battery charging cable. [Ⓢ]

Note: Set the 'Others' as DC1/DC2 input source to enable lead-acid battery charging.
Clamp the positive connector(red) to the positive battery terminal and negative(black) to the other.
The Max. input current is 8.2A.

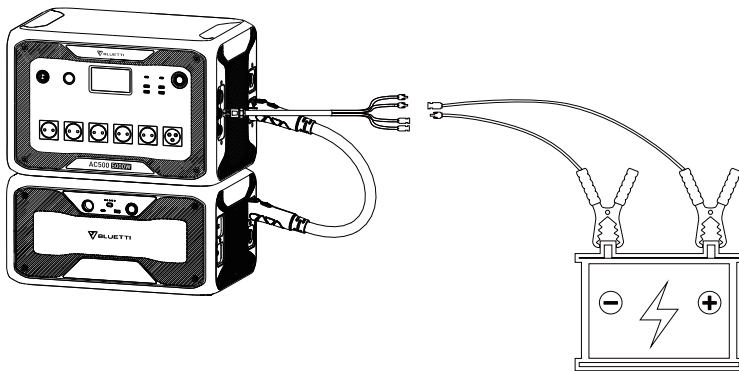

[Ⓢ] The lead-acid charging cable is for charging AC500 ONLY.

Dual Charging

Set the 'PV' as DC1/DC2 input source to enable AC/Generator + PV Charging.

Set the 'Others' as DC1/DC2 input source to enable AC/Generator + Adapter/Car/Lead-acid Battery Charging.

Turn on the 'PV Parallel Enable' to enable excessive PV charging (>1500W, <150V).

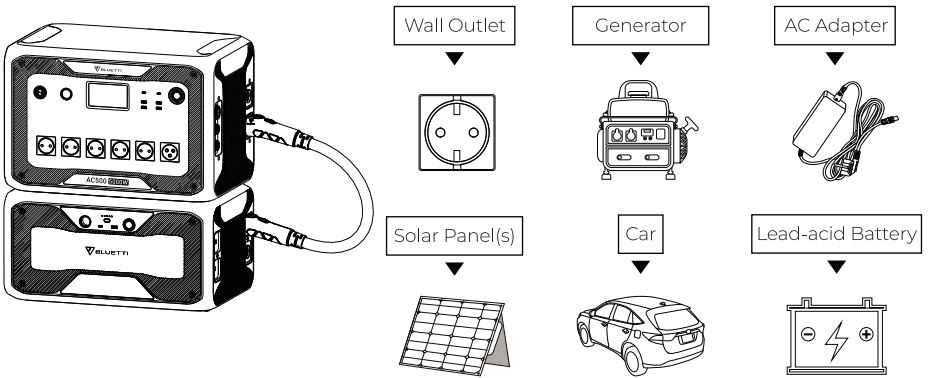

Discharging

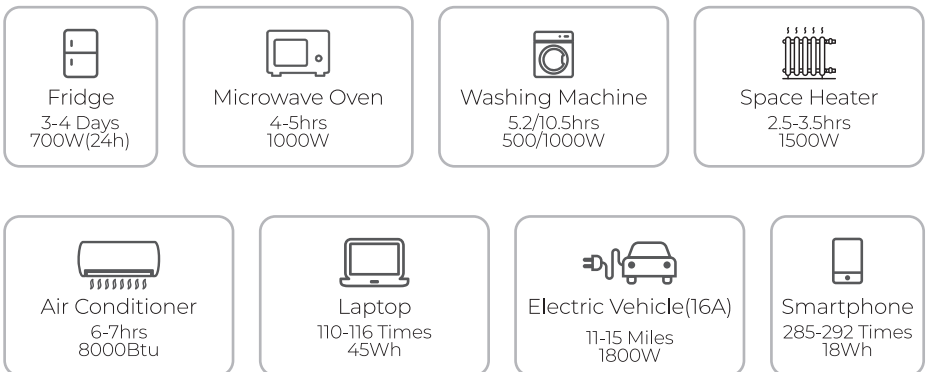

$6144\text{Wh}^* \times \text{DoD} \times \eta \div (\text{load power}) = \text{charging time (estimated)}$

* Take the AC500+2*B300S combo as an example.

Note: DoD refers to the Depth of Discharge, η is the local inverter efficiency.

DoD=95%, η =90%.

DoD may vary depending on ambient-operating temperature and discharge rate.
Load power and charging time are measured in Watt and Hour.

Capacity Expansion

AC500 supports up to 6 expansion batteries for a total of 18,432Wh capacity. Connect AC500 to B300S via the P150D battery expansion cable, or B300 via the P150D to P090D cable. For more details, please refer to B300S or B300 User Manual.

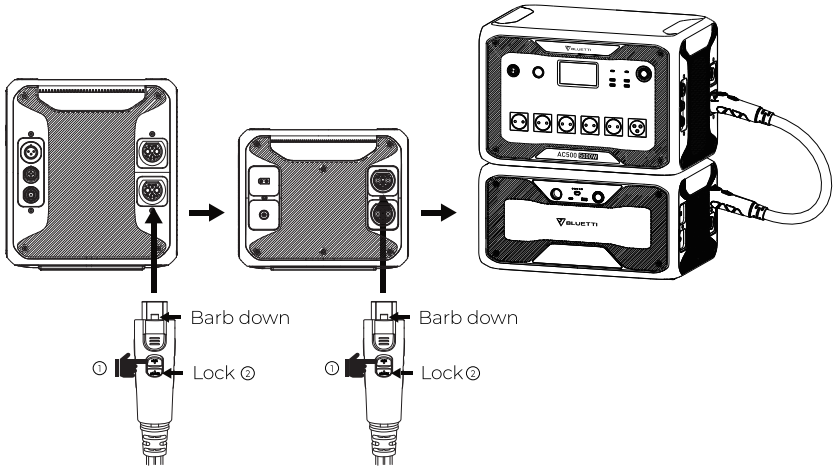

Note: If there's only one B300S connected, the combo delivers a maximum output of 4500W. To get 5000W output, please connect at least one expansion battery to each expansion port.

UPS

Plug the AC500 + B300S combo to a standard wall outlet or tie them to the grid. When the grid fails, the combo steps in and provides power for connected devices.

Plug-in UPS:

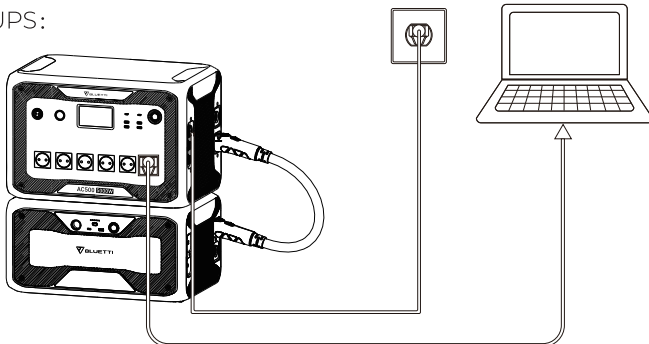

Grid-tied UPS:

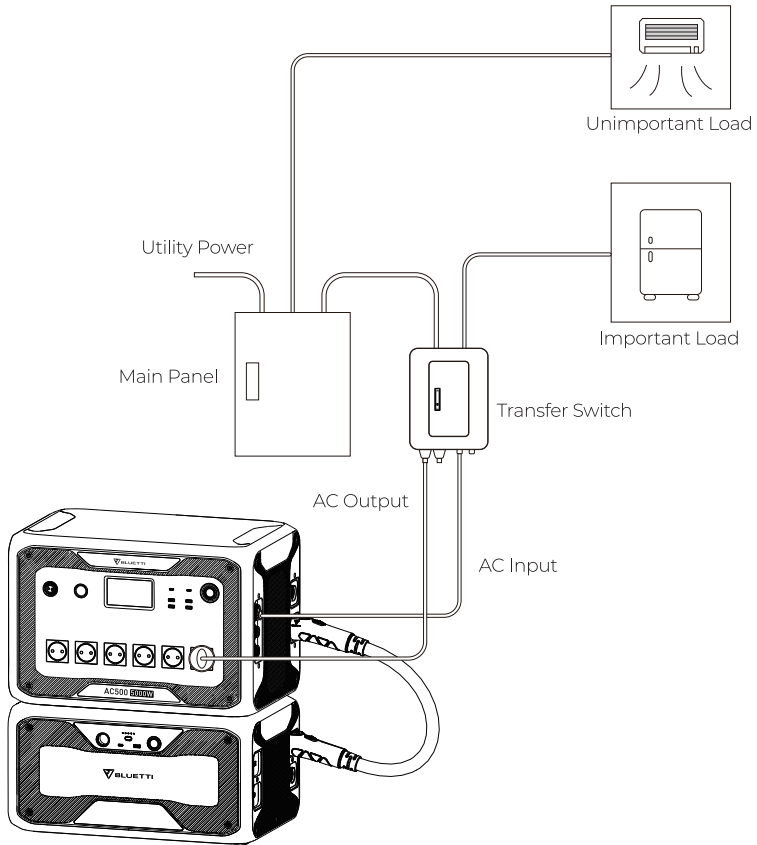

* The grid-tied UPS should be built by a qualified electrician. Please contact BLUETTI Customer Service for details.

AC500 has 4 UPS modes-Standard, Time Control, PV Priority, and Customized UPS, and BLUETTI's UPS mode guide is as follows:

1. The standard UPS mode is good for regions with unstable grid power supply.
2. The Time Control UPS mode will save your electricity bills by setting the charging and discharging time.
3. The PV Priority UPS mode is better for regions with plenty of sunlight all the year.
4. The Customized UPS mode allows you to design your power supply system.

Please refer to **BLUETTI Support** on **YouTube** for detailed instructions.

BLUETTI APP

Download the app from App Store or Google Play and follow the BLUETTI APP INSTRUCTIONS to better control and monitor the AC500 + B300S combo.



Power Lifting Mode

This mode can be enabled in BLUETTI App. When on this mode, the combo can power high drain pure resistive loads[Ⓢ]($\leq 6000W$), while the rated output power remains 5000W.

Note: Make sure the combo disconnects the grid and the B300S doesn't overload. The AC500 detects the resistance of devices and adjusts the output voltage automatically. The mode fails when the AC500 drops below 70% of its rated voltage.

Ⓢ Includes heaters, irons or any other devices consisting of heating elements only.

Appendix

FAQs (Frequently Asked Questions)

Q: Can I use third-party solar panels to charge this product?

A: Yes, you can. As long as the specs of solar panels on DC1 or DC2 input fall in below range:

OCV&Vmp: 12-150V

Input Power: 1500W Max.

With the same power connector (MC4)

Q: Why can't the unit be charged when the solar panels are connected?

A: Please follow below steps:

- 1) Press the 'PV' on LCD screen to check whether the solar panels are connected successfully.
- 2) Check the connection of solar panels and the PV input cable.
If the symptom persists, please contact BLUETTI Customer Service.

Q: How long will it take to switch the UPS?

A: 20ms.

Q: How to upgrade the firmware?

A: Connect the unit with BLUETTI App, then you can over-the-air (OTA) upgrade the firmware including ARM, DSP, HMI, and BMS.

Technical Support

Should you require any further assistance, please do not hesitate to contact BLUETTI Customer Service.

For more information, please visit:



@ BLUETTI Support
@ BLUETTI Official



@ bluetti_inc



@ BLUETTI EU CLUB
@ Bluetti Europe
@ bluetti.inc



@ bluetti_europe
@ bluetti_us



service@bluetti.com

EU	REP	Company: POWEROAK GmbH Address: Lindwurmstr. 114, 80337 München Germany Mail: logi@bluetti.de
-----------	------------	-----------------------------------------------------------------------------------------------------

UK	REP	Company: POWEROAK ENERGY UK CO.,LTD Address: Unit 2, NorthGate, Bolsover Business Park, Woodhouse Lane Chesterfield England S44 6BD Mail: poweroak.eu@bluetti.com
-----------	------------	----------------------------------------------------------------------------------------------------------------------------------------------------------------------------





Just Power On